

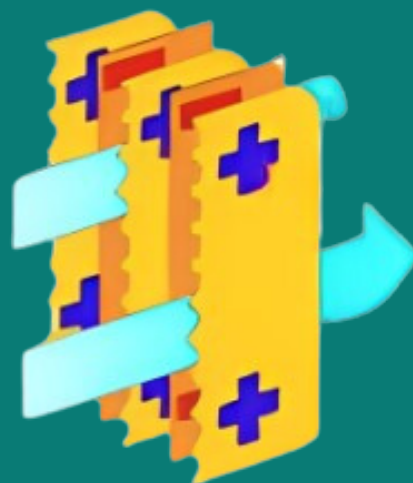

ARWEK



Sobre nós





A Arwek® possui mais de 5 décadas de experiência no mercado de exaustores eletrostáticos, destacando-se pela inovação e qualidade. Sua tecnologia de ponta e suporte técnico especializado, aliados ao cumprimento das normas de qualidade, a diferenciam no mercado.

A empresa prioriza a qualidade em todas as etapas, desde o desenvolvimento até a entrega dos produtos, oferecendo uma ampla gama de equipamentos para cozinhas residenciais e profissionais. Comprometida com a satisfação do cliente, a Arwek® garante produtos duráveis e acompanha cada venda com um Certificado de Garantia, demonstrando seu compromisso contínuo com a excelência.

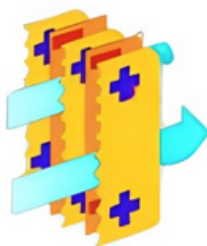

Lâminas com
tecnologia
Hayashi



Qual sistema utilizamos?





Sistema Hayashi: Uma Solução Completa

Nossa metodologia é uma solução completa de tratamento de ar que integra tecnologias e processos inovadores para atender às necessidades específicas de cozinhas comerciais.

Combinando sistemas eletrostáticos, unidades de tratamento de ar (UTA) e insuflamento e exaustão, oferecemos uma abordagem abrangente para eliminar vapores, odores e impurezas do ar, proporcionando um ambiente limpo e seguro para cozinhar.

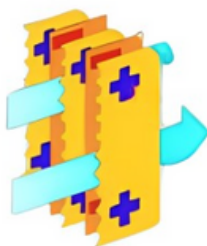

Lâminas com
tecnologia
Hayashi



Benefícios do Sistema





Benefícios do Sistema

O controle de qualidade do ar elimina vapores e gases do cozimento, purificando o ar e removendo odores e microrganismos nocivos. A eficiência energética é melhorada ao reduzir perdas de calor e superaquecimento, economizando custos operacionais. Mantém a higiene e segurança alimentar, essencial para prevenir contaminações e doenças. Proporciona conforto térmico para os funcionários da cozinha. A instalação e manutenção são simplificadas, reduzindo custos de mão-de-obra e garantindo o funcionamento contínuo do sistema.

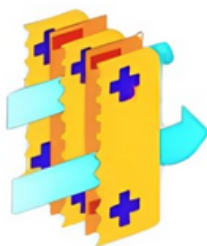

Lâminas com
tecnologia
Hayashi



Onde estamos?

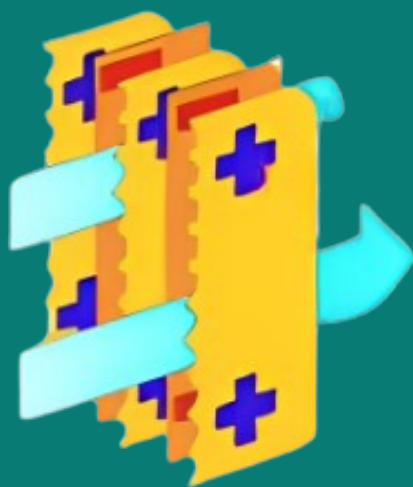

O Escritório



A Fábrica

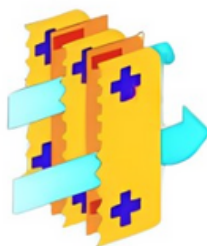

Lâminas com
tecnologia
Hayashi



Aplicabilidades

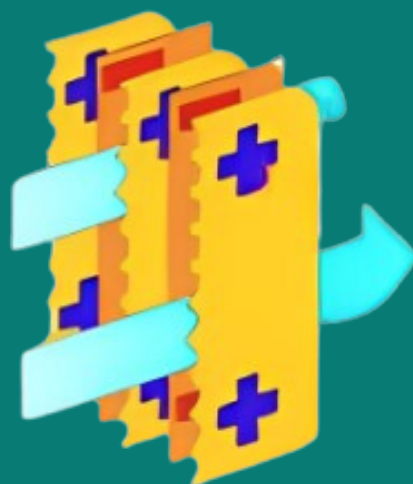



A Arwek se destaca por suas realizações em vários setores, otimizando operações e garantindo eficiência e qualidade.

Atua em restaurantes, lanchonetes, padarias, hotéis, cantinas industriais, cozinhas de hospitais, escolas e universidades, adaptando-se às necessidades específicas de cada área e promovendo excelência operacional e satisfação dos clientes.

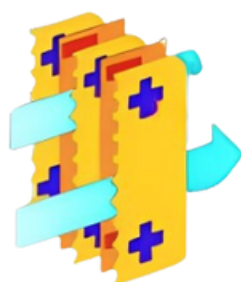
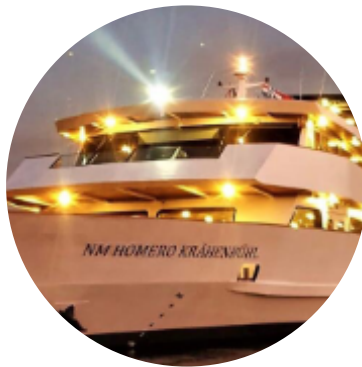

Lâminas com
tecnologia
Hayashi



Cientes e Regiões Atendidos

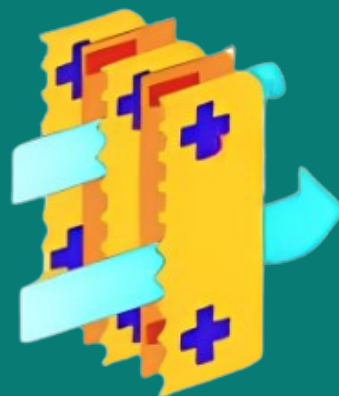



Cientes Atendidos

A Arwek, que faz parte do grupo Hayashi System, já atendeu mais de 1 Milhão de clientes, incluindo grandes nomes como Burger King, Bob's, Pizza Hut, Unilever, Cinemark, Hilton, entre outros. Hospitais, hotéis e universidades também são clientes satisfeitos que aprovam e recomendam seu trabalho.

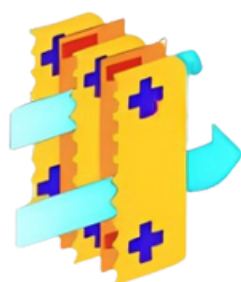

Lâminas com
tecnologia
Hayashi

Atendemos em todo Brasil.

A Nanoar atende a todas as regiões do Brasil, incluindo estados como SP, AC, AM, AP, BA, CE, DF, ES, GO, MA, MG, MS, MT, PA, PB, PE, PI, PR, RJ, RN, RO, RR, RS, SC, SE, TO.

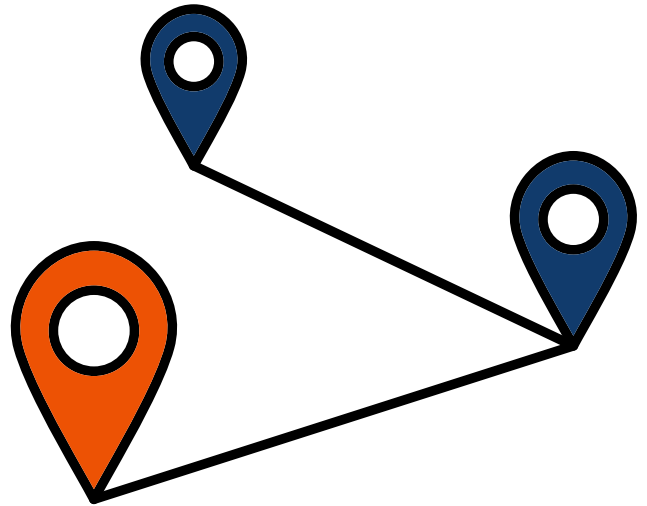

Em São Paulo, cobre várias cidades, como Guarulhos, Campinas, São Bernardo do Campo, Santo André, Osasco, São José dos Campos, Ribeirão Preto, Sorocaba, entre outras.

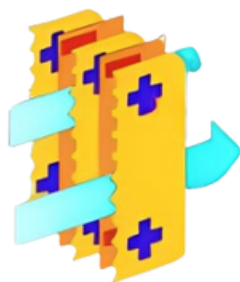

Lâminas com tecnologia Hayashi



Área de Atuação

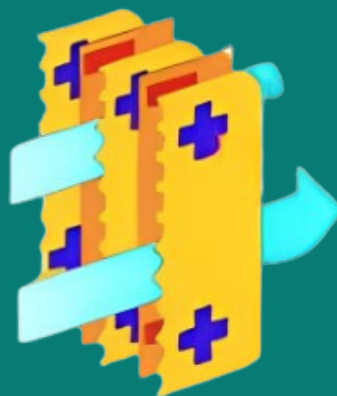

A Arwek oferece soluções em sistemas de exaustão e ventilação para diversos segmentos, como varandas gourmet, ambientes comerciais e de saúde.

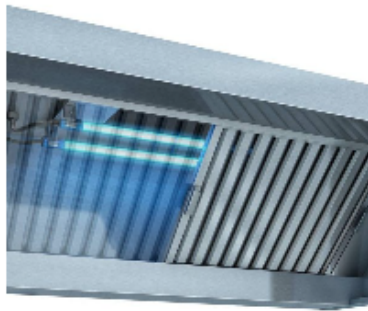

Fornece coifas, exaustores e sistemas de purificação de ar para residências, embarcações e cozinhas profissionais, garantindo segurança e qualidade com tecnologia avançada.

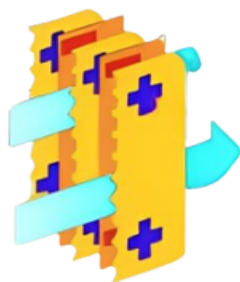

Lâminas com tecnologia Hayashi

ARWEK

Produtos, Acessório e Opcionais

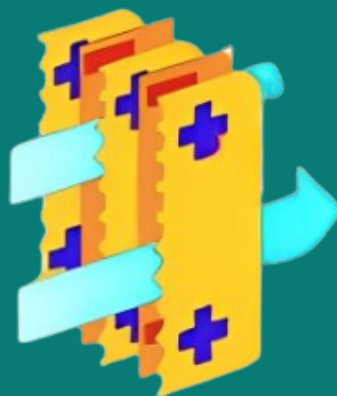

A Arwek oferece diversos produtos para sistemas de exaustão e ventilação, incluindo esterilização de ar portátil, captosres, cúpulas de exaustão, separadores de névoa de óleo, unidades de tratamento de ar e ionizadoras.

Também disponibiliza coifas para várias aplicações, como quiosques, food trucks, churrasqueiras em edifícios e varandas gourmet.

Além disso, possui unidades específicas como o Precipitador Hidro Lavador de Gases e a Unidade de Descontaminação Hayashi.

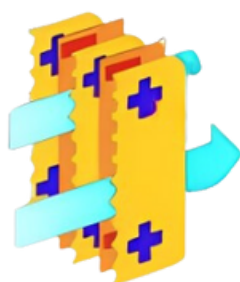

Lâminas com
tecnologia
Hayashi

Produtos

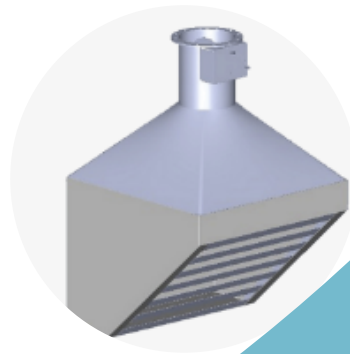
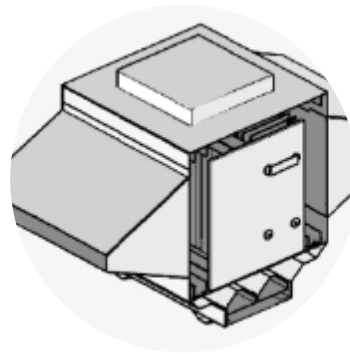
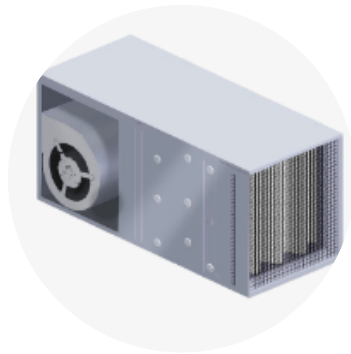
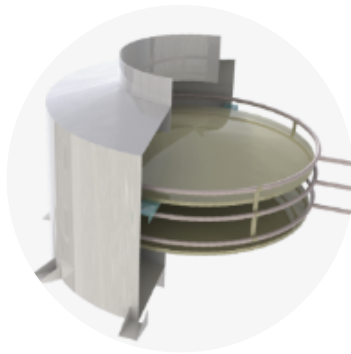
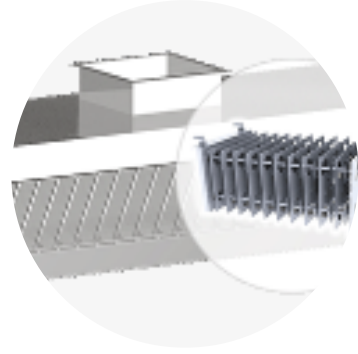
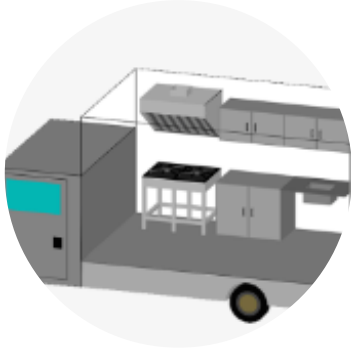

Acessórios e Opcionais

A Nanoar oferece diversos acessórios e opcionais para sistemas de exaustão e ventilação, incluindo o Sistema Jet Blocker, exaustores industriais, dampers, módulos de filtro eletrostático, filtro inercial ciclônico, módulo de filtro de carvão ativado MC ZIG-ZAG, filtro UV, sistemas de extinção de incêndio em dutos de exaustão à base de CO₂, e quadros elétricos com medidas de segurança contra incêndio em cozinhas profissionais.

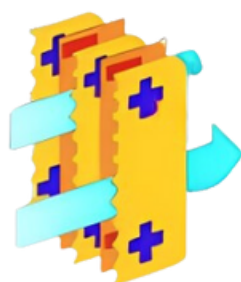
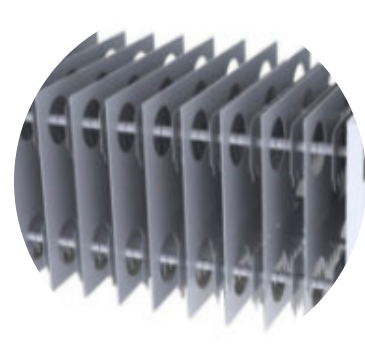
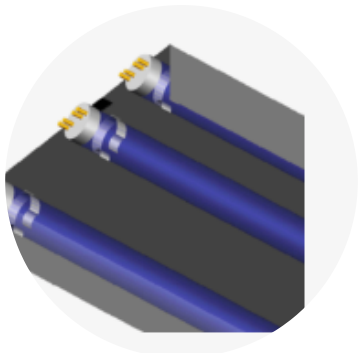
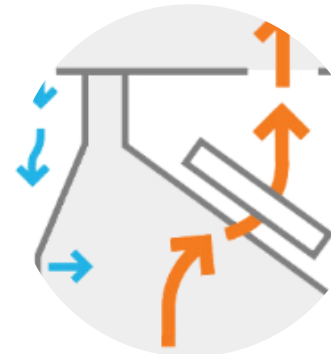
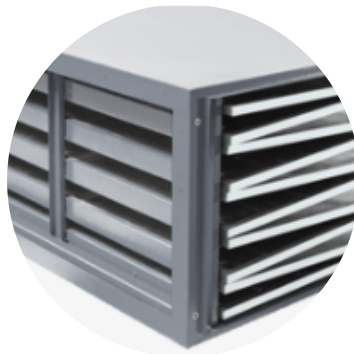

Lâminas com
tecnologia
Hayashi

Gostaria de saber mais?

Acesse nosso site!

arwek.com

Se preferir, entre em contato

(11) 932169701



ARWEK