

# ARWEK

## Soluções de Exaustão Especializadas para Fritadeiras





## DESTAQUES DO SISTEMA DE EXAUSTÃO

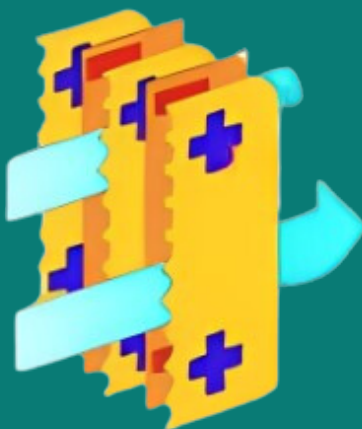

- Sistema Autocompensado de Ar Integrada de Borda;
- Não há necessidade de conexão com o duto de exaustão;
- Filtro Eletrostático ESP Hayashi System gerador de Ions do
- Ionizador;
- Insuflação e recirculação integrados de borda – Estação Exaustão de cozimento móvel Coifa com Aspiração Frontal ou Lateral "Jet Blocker", Tecnologia Hayashi de jato de captura;
- Em conformidade com as normas ABNT NBR 14518:2019 e
- ASHRAE;
- Coifa de Borda para cozedor de massa;
- Alta eficiência na eliminação de odores de fritura;

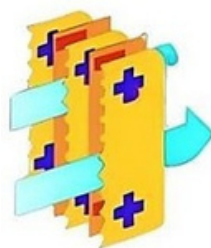

Lâminas com  
tecnologia  
Hayashi



APLICAÇÕES VERSÁTEIS EM AMBIENTES DE FRITURA

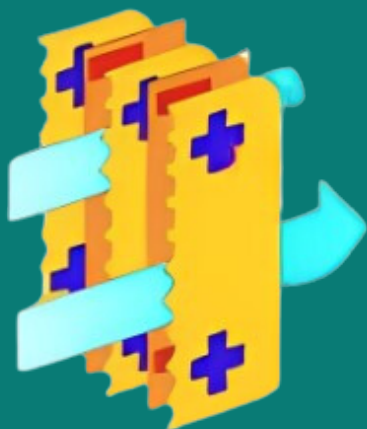

- **Estádios;**
- **Ao lado da piscina;**
- **Shoppings centers;**
- **Caminhões de comida;**
- **Salas para banquetes;**
- **Quiosque com praça de alimentação;**
- **Telhado com arranha céus alto;**
- **Centros de convenções;**
- **Espaços palivalentes;**
- **Campo de de golfe com 9 buracos;**
- **Nível mais alto de arranha-céus;**
- **Restaurante no hotel;**

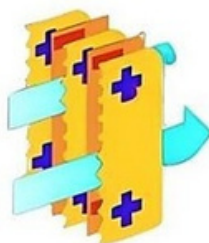

Lâminas com  
tecnologia  
Hayashi



CAPTOR DE BANCADA COM FILTRO ELETROSTÁTICO ESP

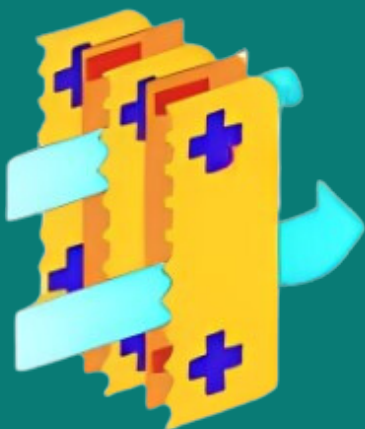

Nosso captor de bancada, certificado pela UL 710B, atende às demandas dos chefs mais exigentes. Compatível com uma variedade de aparelhos, proporciona flexibilidade no menu. Requer 208/3/60 e serviço de 60 ou 100 A, com tomadas integradas. Opção adicional de 120V disponível para base refrigerada.

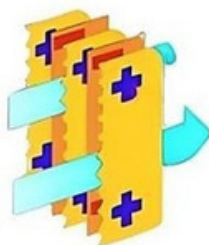
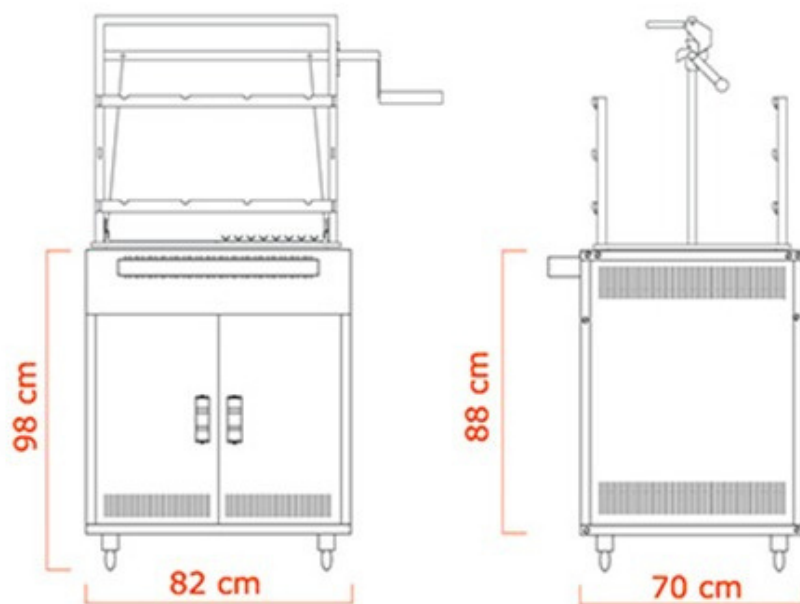

Lâminas com  
tecnologia  
Hayashi



Se interessou por algum  
produto?

Entre em contato conosco! (11)932169701

### **Horário e Atendimento**

Segunda à Sexta, das 8h00 às 17h00 Sábado das 8h00 às  
12h00.

Se preferir, visite nosso Showroom

Rua João de Sousa Dias, 412- Campo Belo- São  
Paulo



Todos os produtos ARWEK possuem direitos autorais

**ARWEK**

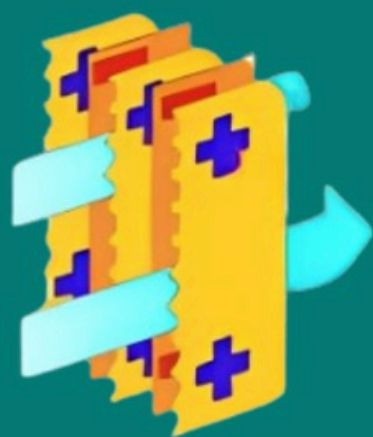

Lâminas com  
tecnologia  
Hayashi